

CHEMICAL ENERGY FUEL

1. What is meant by a redox reaction?

The reaction in which oxidation and reduction takes place simultaneously is called a redox reaction.

Oxidation: addition of O₂ / removal of H₂ / loss of electrons.

Reduction: addition of H₂ / removal of O₂ / gain of electrons.

2. What is meant by electrochemical cell?

A cell is a device which converts chemical energy into electrical energy is called **electrochemical cell**.

Electrochemical cell consists of two electrodes immersed in an electrolyte and connected externally with a metal wire. It is also called as galvanic cell or voltaic cell

Electrode is a set up in which the metal is immersed in its salt solution.

Anode: It is a -ve electrode where the electrons leave from it, or the electrode where oxidation takes place.

Cathode: It is a +ve electrode where the electrons enter through it, or the electrode where reduction takes place.

3. Define Electrode potential and standard electrode potential? How it is measured?

If a metal is in contact with solution of its own ions, the metal either gains electrons or loses electrons. The tendency of an electrode to lose or gain electrons when it is in contact with its own ions in the solution is called **electrode potential**.

The tendency to gain electrons is called “**reduction potential**”.

Similarly, the tendency to lose electrons is called “**oxidation potential**”.

Oxidation and reduction potentials of an electrode have same magnitude but opposite sign.

e.m.f of electrochemical cell:

The difference between potentials of the two half cells is known as e.m.f

$$E_{\text{cell}} = E_{\text{R}} - E_{\text{L}} \text{ (Both are reduction potentials)}$$

Standard electrode potential:

The tendency of an electrode to lose or gain electrons when it is in contact with the solution of its own ions of **unit molar** concentration (in case of gas electrode 1 atm pressure) at **25°C** is called standard electrode potential.

Measurement of electrode potential:

It is impossible to measure the absolute value of a single electrode potential.

We can only measure the difference between two electrodes potentiometrically by combining them to form a complete cell.

By arbitrarily fixing potential of one electrode as zero, it is possible to assign numerical values to potentials of various electrodes.

Ex: “Standard Hydrogen Electrode”: Pt, H₂ (g) (1 atm), H⁺ (aq) (C=1M)

All other single electrode potentials measured with respect to SHE are referred to as potentials on the hydrogen scale.

3. What is meant by Electro chemical series? Give its Significance.

Electrochemical Series:

“The arrangement of electrodes (metals & non-metals) in increasing order of their standard reduction potential values is called electrochemical series or electromotive or activity series.

Li, Mg, Zn, Fe -----H₂-----Cu, Ag, Cr, Cl₂, F₂

Significance of electrochemical series:**1. Oxidizing and reducing strengths:**

The metal/ non metal with low standard reduction potential(SRP) will act as strong reducing agent while the metal/non metal with high SRP will act as strong oxidizing agent.

Top most elements in the series shows the Oxidation tendency and act as reducing agents and bottom elements show Reduction tendency and act as Oxidizing agents.

The reducing nature decreases down the series and oxidizing nature increases down the series.

2. Displacement Tendency:

A metal with lower SRP will displace metal with higher SRP from its solution.

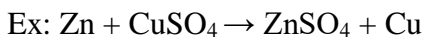

$$E_{\text{Zn}^{2+}/\text{Zn}} = -0.76\text{V}; E_{\text{Cu}^{2+}/\text{Cu}} = 0.34\text{V}$$

3. Feasibility of a Redox reaction:

If E_{cell} is +ve – redox reaction is spontaneous

If E_{cell} is -ve – redox reaction is non spontaneous

$$E_{\text{cell}} = E_{\text{cathode}} - E_{\text{anode}} \text{ (both are SRPs)}$$

$$= E_R - E_L$$

$$= 0.34 - (-0.76) = +1.1\text{V}$$

$\text{Zn} + \text{CuSO}_4 \rightarrow \text{ZnSO}_4 + \text{Cu}$; Spontaneous reaction.

4. Calculation of Equilibrium constant

$$\text{By the equation } E = \frac{RT \log K_c}{nF} \quad K_c = \text{Equilibrium constant}$$

if E electrode potential is known K_c can be determined by above equation

5. Derive Nernst Equation for emf of a cell?

The Nernst Equation: (Effect of Solution concentration on E_{cell})

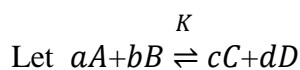

$$k = \frac{[C]^c [D]^d}{[B]^b [A]^a}$$

$$-\Delta G = -\Delta G^0 - RT \ln K$$

$$\Delta G = \Delta G^0 + RT \ln K$$

$$\text{since } \Delta G = -nFE_{\text{cell}} \text{ and } \Delta G^0 = -nFE_{\text{cell}}^0$$

$$nFE_{\text{cell}} = nFE_{\text{cell}}^0 - RT \ln K$$

$$E_{\text{cell}} = E_{\text{cell}}^0 - \frac{RT}{nF} \ln K$$

$$E_{\text{cell}} = E_{\text{cell}}^0 - \frac{2.303RT}{nF} \log K$$

$$E_{\text{cell}} = E_{\text{cell}}^0 - \frac{2.303RT}{nF} \log \frac{[C]^c [D]^d}{[A]^a [B]^b}$$

R- Gas Constant = 8.314J/sec,

T- Absolute temperature – 298K,

F – Faraday – 96500c,

$$\frac{2.303RT}{F} = 0.0591$$

$$E_{\text{cell}} = E_{\text{cell}}^0 - \frac{0.0591}{n} \log \frac{[C]^c [D]^d}{[A]^a [B]^b}$$

$$E_{\text{cell}} = E_{\text{cell}}^0 - \frac{2.303RT}{nF} \log \frac{[\text{Products}]}{[\text{Reactants}]} \quad \text{at } 25^\circ\text{C}$$

n- No. of electrons involved in the reaction

6. Explain the construction and working of Hydrogen electrode**Hydrogen Electrode:**

- Hydrogen electrode is the primary standard electrode.
- It consists of a small Platinum strip coated with Platinum black as to adsorb H₂ gas.
- Platinum is welded to the Pt strip and sealed in a glass tube as to make contact with the outer circuit.
- The Platinum strip and glass tube is surrounded by an outer glass tube which has an inlet for H₂ gas at top and a no. of holes at the base for the escape of excess of H₂ gas.
- The Platinum strip placed in an acid solution which has H⁺ ions of 1M concentration. Pure hydrogen gas passed through the inlet at 1 atmospheric pressure.
- A part of gas is adsorbed and the rest escapes through holes. This gives equilibrium between the adsorbed H₂ and H⁺ ions in the solution.
- The temperature of the cell is maintained at 25 °C. By international agreement the H₂ electrode is assigned a potential of 0.0 volts.
- The electrode represented as **Pt, H₂ (g) / H⁺ (aq)**.
- Hydrogen electrode can act as anode or cathode w.r.to the other electrode to which it is connected.
- Anode: Oxidation: H₂ (g) → 2H⁺ + 2e⁻ (E_{ele} = 0.0V)
- Cathode: Reduction: 2H⁺ + 2e⁻ → H₂ (g) (E_{ele} = 0.0V)

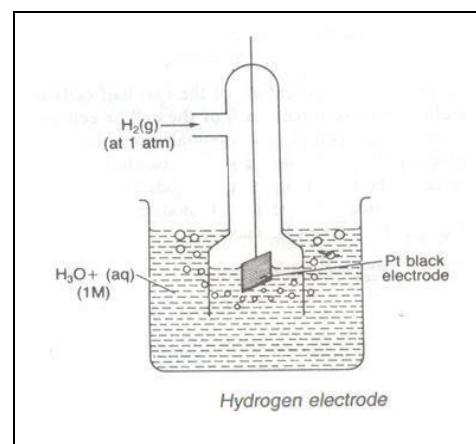

$$E_{H^+/H_2} = E^0_{H^+/H_2} - \frac{0.0591}{2} \log \frac{[P_{H_2}]}{[H^+]^2}$$

$$E_{H^+/H_2} = 0.0591 \log [H^+]$$

$$E_{H^+/H_2} = -0.0591 \text{pH}$$

- Thus, potential of hydrogen electrode depends on pH of the solution. It is used to measure pH of solutions.
- For example, if the H₂ electrode is coupled with Saturated Calomel Electrode (SCE),

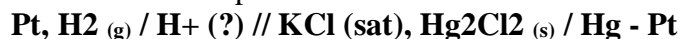

$$E_{\text{cell}} = E_{\text{SCE}} - E_{\text{H}_2}$$

$$E_{\text{cell}} = 0.242 - (-0.0591 \text{pH})$$

$$E_{\text{cell}} = 0.242 + 0.0591 \text{pH}$$

$$\text{pH} = \frac{E_{\text{cell}} - 0.2420}{0.0591}$$

Drawbacks:

1. Its construction is difficult i.e. it is difficult to maintain the concentration of H⁺ ions 1M and pressure 1 atm.
2. Cannot be used in the presence of ions of many metals.
3. It cannot be used in solutions containing Redox systems.

7. Explain the construction and working of calomel electrode?

- Since a standard hydrogen electrode is difficult to prepare and maintain, it is usually replaced by other reference electrodes, which are known as secondary reference electrodes.
- These are convenient to handle and are prepared easily.
- This type of reversible electrodes consists of a metal in contact with one of its sparingly soluble salts and a solution of a soluble salt having a common anion with the sparingly soluble salt.

Ex: i) Calomel Electrode (ii) Silver – Silver Chloride electrode.

(i) Calomel electrode:

- It consists of mercury at the bottom over which a paste of mercury-mercurous chloride is placed.

- A solution of potassium chloride is then placed over the paste.
- A platinum wire sealed in a glass tube helps in making the electrical contact.
- The electrode is connected with the help of the side tube on the left through a salt bridge with the other electrode to make a complete cell.
- The electrode is represented as $\text{Pt, Hg/ Hg}_2\text{Cl}_2, \text{Cl}^-_{(\text{aq})}$
- The potential of the calomel electrode depends upon the concentration of the potassium chloride solution.
- If potassium chloride solution is saturated, the electrode is known as saturated calomel electrode (SCE)
- If the potassium chloride solution is 1 N, the electrode is known as normal calomel electrode (NCE)
- For 0.1 N potassium chloride solution, the electrode is referred to as decinormal calomel electrode (DNCE).
- The electrode reaction when the electrode acts as cathode is: $2 \text{Hg}_2\text{Cl}_2 + 2\text{e}^- \rightarrow 2\text{Hg} + 2\text{Cl}^-$
- The reduction potentials of the calomel electrodes on hydrogen scale at 298K are as follows:
Saturated KCl = 0.2415 V
1.0N KCl = 0.2800 V
0.1N KCl = 0.3338 V
- Calomel electrode acts as either anode or cathode w.r.to the other electrode connected to it.
- If it acts as anode, it involves oxidation: $2\text{Hg} \rightarrow \text{Hg}_2^{2+} + 2\text{e}^-$
 $\text{Hg}_2^{2+} + \text{Cl}^- \rightarrow \text{Hg}_2\text{Cl}_2$

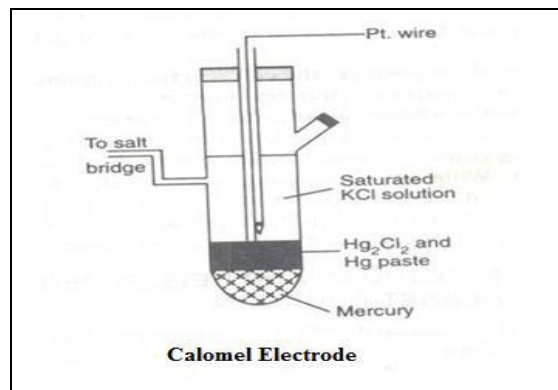

results in fall of concentration of Cl^- ions.

- If it acts as cathode, it involves reduction

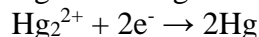
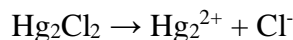

results increase in concentration of Cl^- ions.

Thus, Calomel electrode is reversible to Cl^- ions.

The reduction potential of calomel electrode is given by

$$E_{SCE} = E^0_{SCE} - \frac{0.0591}{2} \log \frac{[\text{Hg}]^2 [\text{Cl}^-]^2}{[\text{Hg}_2\text{Cl}_2]}$$

$$E_{SCE} = 0.280 \text{ V} - 0.0591 \log [\text{Cl}^-]$$

$$\text{Since } [\text{Hg}] = [\text{Hg}_2\text{Cl}_2] = 1 \text{ and } E^0_{SCE} = 0.280 \text{ V}$$

- The electrode potential of any other electrode on hydrogen scale can be measured when it is combined with calomel electrode.
- The emf of such a cell is measured.
- From the value of electrode potential of calomel electrode, the electrode potential of the other electrode can be evaluated.

Advantages:

1. Its construction is very easy
2. Results of cell potential measurements are reproducible.

Disadvantages:

1. Since Hg_2Cl_2 breaks at 500C, it can't be used above this temperature.

Battery Chemistry:**1. Define battery? Explain construction and working of dry or Laclanche cell with neat sketch.**

Battery is defined as it is an electrochemical cell or several electrochemical cells in series that can be used as a source of direct electrical current at a constant voltage.

Dry or Laclanche cell:

- It is a primary cell or pure electrochemical cell which consists of only Discharging cycle can convert chemical energy to electrical energy.

- **Anode:** Zn can
- **Cathode:** Graphite surrounded by MnO_2 .
- **Electrolyte:** $ZnCl_2 + NH_4Cl + Starch$

Construction:

It consists of graphite rod at the centre surrounded by a paste consists of MnO_2 , NH_4Cl and $ZnCl_2$ made with starch.

- This entire assembly is placed inside a thin Zinc can

At Anode: $Zn \longrightarrow Zn^{2+} + 2e^-$

At Cathode: $2MnO_2 + H_2O + 2e^- \longrightarrow Mn_2O_3 + 2OH^-$

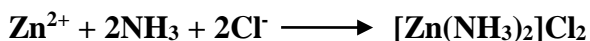
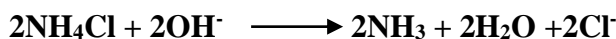
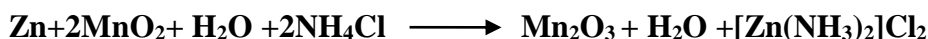
**Net reaction:**

- **EMF of the cell:** 1.5V
- **Dry cells are used in flashlights, transistor radios, calculators etc**
- **Disadvantages:**
- When electricity is drawn quickly the products of secondary reactions will build up, so there is sudden drop in potential observed.
- Even though cell is not in use due to acidic electrolyte cell will discharge continuously.

2. Explain alkaline battery.**ALKALINE BATTERY:**

- **Anode:** Zn can
- **Cathode:** Graphite surrounded by MnO_2 .
- **Electrolyte:** $KOH + Zn$ powder

Construction:

It consists of graphite rod at the centre surrounded by a paste consists of MnO_2 , the electrolyte KOH is mixed with Zn powder, this entire assembly is placed inside a thin Zinc can

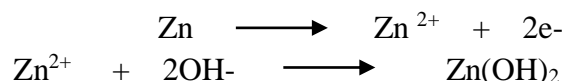
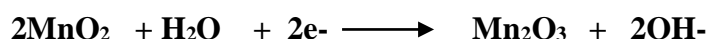
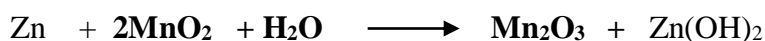
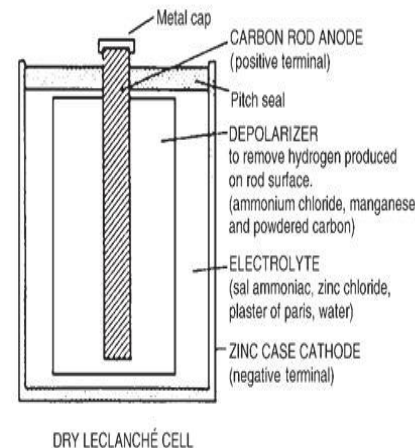
Reactions at Anode:**Reactions at Cathode:****Net reaction:****EMF of the cell:** 1.5V

3. What are storage devices? Explain the construction and working of a lead acid accumulator.

A. Storage device: These are secondary cells in which reactants are regenerated by passing direct current from an external source

Ex: Lead acid battery, Ni-cad battery, Li-ion battery

Lead acid accumulator:

- It is a secondary cell which consists of both Discharging and recharging component can convert chemical energy to electrical energy by acting as electro chemical cell and convert electrical energy into chemical energy by acting as electrolytic cell.
- Anode: spongy lead
- Cathode: PbO₂ coated lead.
- Electrolyte: 20% H₂SO₄

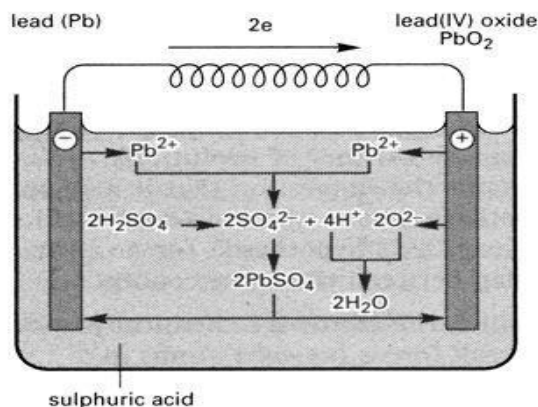

The cell represented as **Pb, PbSO₄ (s) / H₂SO₄ (30%) / PbO₂ (s), Pb**

Construction:

It consists of lead as anode and PbO₂ coated lead as a cathode immersed in a 20% H₂SO₄ electrolyte either a single pair or series of pairs immersed in a electrolyte with porous partition between the pairs. When it is fully charged it can act as an electrochemical cell and convert chemical energy into electrical energy

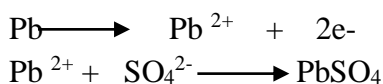
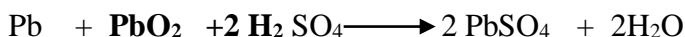
Reactions at Anode:**Reactions at Cathode:****Net reaction:**

EMF of the cell: 1.8 - 2.2V

when it is discharged completely it has to get recharged by connecting electrodes to + and - terminals of a power source and making a cell as electrolytic cell which convert electrical energy into chemical energy.

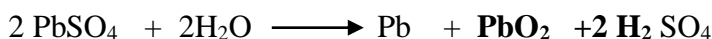
Reactions at '-' terminal:**Reactions at '+' terminal:****Net reaction:**

In discharging process the electrolyte component acid is converted into equivalent of water and in charging process the water is converted to equivalents of acid, thus at any time the concentration or specific gravity of acid will determine the life a battery.

Uses: They are used in automobiles like cars, buses etc

4. Explain working of Nickel cadmium (Ni-cad) battery?(Alkaline cell)

- It is a secondary cell which consists of both Discharging and recharging component can convert chemical energy to electrical energy by acting as electro chemical cell and convert electrical energy into chemical energy by acting as electrolytic cell.
- Anode: Spongy Cadmium
- Cathode: Ni₂O₃ coated Ni
- Electrolyte: 20% KOH

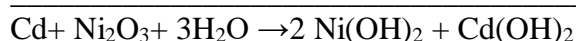
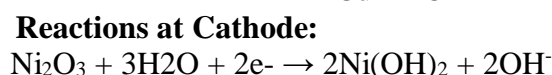
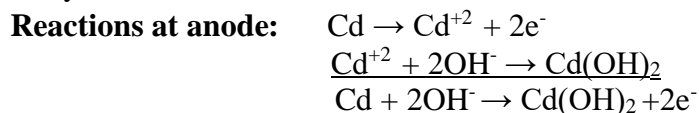

$$E_{\text{cell}} = 1.4\text{V}$$

Advantages:

1. It is very compact, light weighed with good cycle and shelf life.
2. It has very low internal resistance.
3. Used at a wide temperature range and less maintenance.

Uses: Photography, phones, computers, emergency lights and pace makers.

5. Explain working of Li-ion battery?**Lithium – Ion Battery (LIB):**

A LIB is a family of rechargeable battery types in which Li ions move from the –ve to +ve electrode during discharge and back when charging.

Intercalated Li compounds used as the electrode material. Handheld electronics mostly use LIBs based on Lithium Cobalt Oxide (LCO), which offers high energy density.

Construction:

The 3 primary functional components of a Li-ion battery are the –ve, +ve electrode and electrolyte.

–ve electrode made from carbon (graphite) and

the +ve electrode is a metal oxide such as Li-Co-Oxide (LCO), Li-Iron Phosphate (LIP) and Li-Mn-Oxide (LMO).

The electrolyte is a Li salt in an organic solvent (non aqueous) like Li hexa Fluoro Phosphate (LiPF₆). Depending on the material choices the voltage, capacity, life and safety of a Li-ion battery can changes.

Both the electrodes are materials into which, and from which, the Li ions can migrate.

During charging,

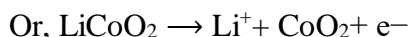
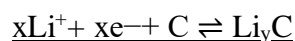

In LIB, the Li ions are transported to and from the cathode or anode with transition metal Cobalt (Co). Li_xCoO₂ being oxidized from Co³⁺ to Co⁴⁺ during charging and reduced from Co⁴⁺ to Co³⁺ during discharge.

Advantages:

1. Wide variety of shapes and sizes.
2. Much lighter.
3. Compounds are environmentally safe.

Disadvantage: Over time charging diminishes cell's capacity

6. What is meant by a fuel cell? Explain working of H₂ - O₂ and Methanol Fuel Cell**Fuel Cell**

A cell which converts chemical energy of a fuel directly into electrical energy is called fuel cell

Fuel + Oxygen \longrightarrow Oxidation products + Electrical energy

Advantages of fuel cells:

1. The energy conversion is highly efficient by fuels
2. Noise and thermal pollution are low
3. harmless by products and eco friendly

Disadvantages:

The initial cost is high

H₂ - O₂ Fuel Cell

- Anode: H₂ the Fuel
- Cathode: O₂ The oxidant
- Electrolyte: 25% KOH
- Electrodes are made of graphite impregnated with finely divided Pt, Pd, Ag, Or Ni

Construction:

It consists of Porous graphite Cylinders impregnated with finely divided Pt, Pd, Ag, Or Ni, in one electrode fuel H₂ is pumped at 50 atm and in the other electrode O₂ is pumped.

The electrolyte is KOH

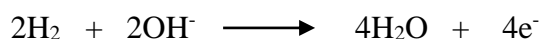
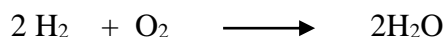
Reactions at Anode:**Reactions at Cathode:****Net reaction:****EMF of the cell: 1.2V**

Electrolytes used most often are aqueous KOH or H₂SO₄ or ion exchange resin saturated with water.

For low temperature operations (ie. -54 to 72^oC) KSCN IN Liq Ammonia is employed.

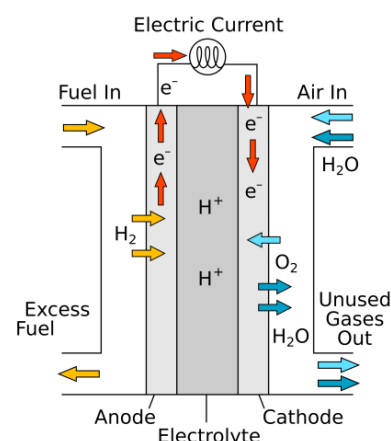
**Applications of Hydrogen - oxygen fuel cell**

- Used as auxiliary energy source in space vehicles, submarines and other military vehicles.
- The product water is a valuable source of fresh water by astronauts.
- Widely used as a source of power in transportation like electric mobiles etc.
- Efficiently employed for power generation which is used for domestic and industrial purpose.

Methanol Fuel Cell

The cell consists of anode and cathode compartments and electrolyte compartment.

Usually the electrodes are made up of platinum since they are inert.

Methanol and water is fed into anodic compartment where methanol undergoes oxidation.

Oxygen is fed into cathodic compartment where it undergoes reduction.

These two are separated by a proton exchange membrane.

The protons generated during oxidation pass through the proton exchange membrane and reaches to cathodic compartment and combines with O₂ to form H₂O

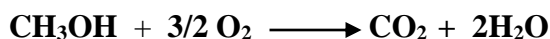
Reactions at Anode:**Reactions at Cathode:****Net reaction:****EMF of the cell:** 1.2V**Advantages:**

Methanol has low carbon content

The OH group is easily oxidisable

Methanol is highly soluble in water.

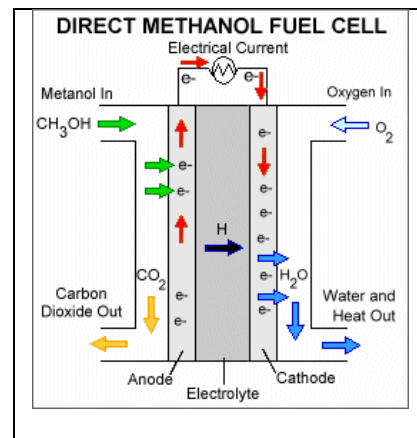
Uses: in military applications.**Solar Energy****1. What is meant by photovoltaic cell**

It is a solar cell which converts light energy into electrical energy. They are developed to supply power to space programmes.

2. Explain construction and working of photovoltaic cell/solar cell?

1. It consists of a semiconducting material in which one region is n-type and an adjacent region is p-type. The boundary between such regions within a single crystal is called p-n junction.
2. In the absence of external voltage, a hole from the p-side moves to n-side and an electron from n-side moves to p-side.
3. Conducting electrons are prevented from entering into the p-side by the negative ions of the acceptor in the lattice.
4. This junction charge i.e., positive in the n-side and negative in the p-side acts as barrier for both the holes and conducting electrons.
5. In the presence of light which falls on the p-n junction, electrons from the valence band are promoted to the conduction band there by generating electron-hole pairs on both sides of the junction. The electron-hole pairs are dissociated into electron and hole on incidence of light.
6. P-n junction acts a barrier for both charge carriers and concentration of holes builds up on p-side and concentration of electrons builds up on the n-side.
7. When the equilibrium concentrations of the carriers exceeds, a drift of holes towards A and a drift of electrons towards B takes place. When A and B are connected with a conductor, flow of current takes place from A to B and flow of electrons takes place from B to A.
8. Solar cells made of gallium arsenide, indium phosphide, CdS/Cu₂S are used.

9. Electrical energy derived is stored by charging lead-acid battery, Ni-Cd battery etc.

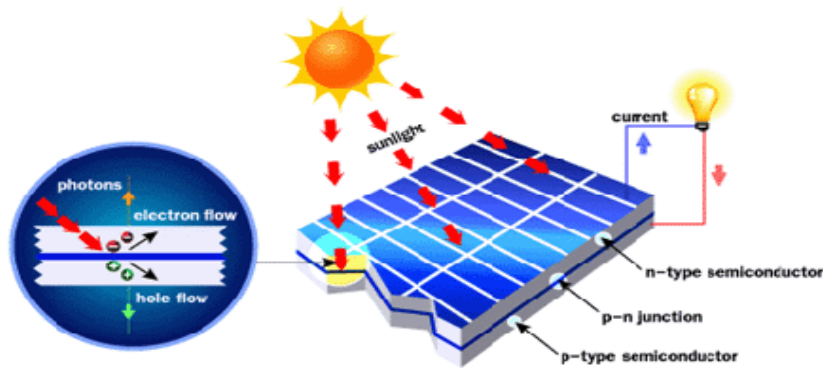

3. Mention the applications of solar cell?

- It is used to produce hydrogen by electrolysis of water.
- The liberated hydrogen is used in hydrogen-oxygen fuel cell.
- They are used in pocket calculators, power supply for rural homes, light houses, irrigation pumps, radio-transmitters, traffic signals etc.
- They are used for power generation in photo voltaic power plants replacing thermal power plants.
- They are also used for developing solar power based air-conditioners.